

DRIVE CHAIN SLIDER

(Refer to the maintenance precautions on page 66).

Check the chain slider (1) for wear.

The chain slider must be replaced if it is worn to the wear limit line (2). For replacement, see your authorized Honda dealer.

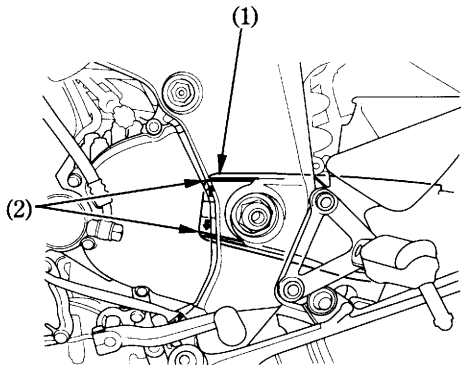

- (1) Chain slider
- (2) Wear limit line