

Measure the clearance (6) between each surface of the left brake disc (7) and the left caliper holder (8) with a 0,7 mm (0,028 in) feeler gauge (9) (see illustration).

If the gauge inserts easily, tighten the right and left axle pinch bolts (3) to the specified torque.

Axle pinch bolt torque:

22 N·m (2.2 kg·m , 16 lb-ft)

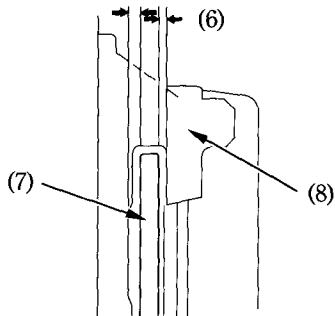

(6) Clearance
(7) Brake disc

(8) Caliper holder

▲ WARNING

* If a torque wrench was not used for installation, see your authorized Honda dealer as soon as possible to verify proper assembly. Improper assembly may lead to loss of braking capacity.

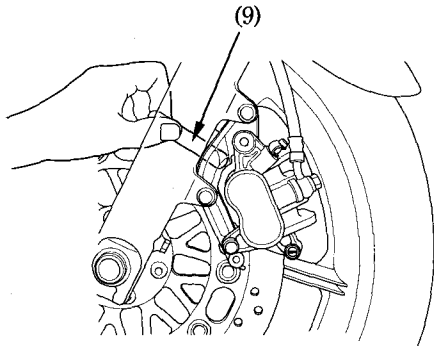

(9) Feeler gauge