

Owner's Manual Storage

The owner's manual storage area (Fig. 2-22) is located under the seat (1).

The owner's manual (2) and spare fuse (3) should be stored in the plastic document bag (4).

To remove the seat, see page 124 .

Be careful not to flood this area when washing your FOURTRAX or riding through water.

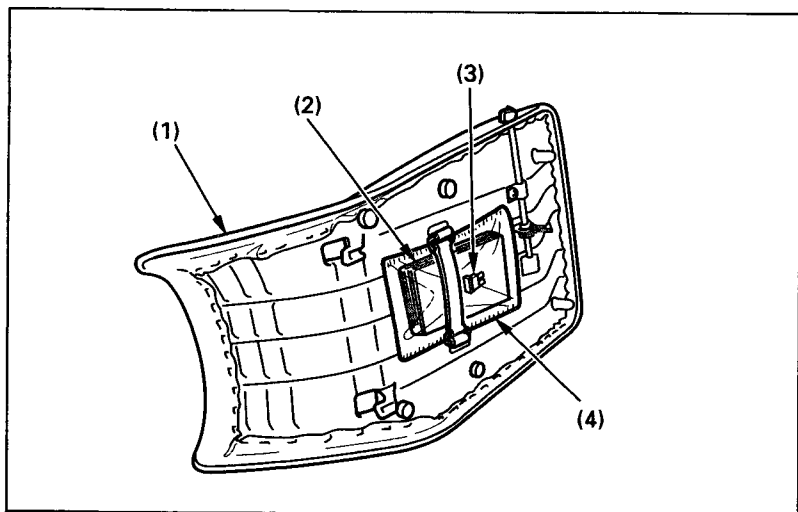

Fig. 2-22

(1) Seat

(2) Owner's manual

(3) Spare fuse

(4) Plastic document bag