

# Controls & Features

---

## Recoil Starter

LEFT SIDE

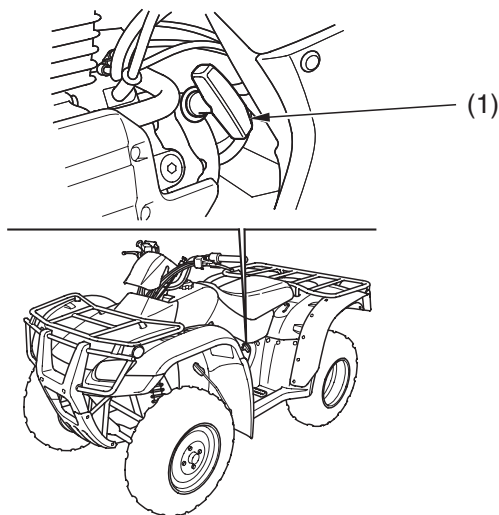

(1) recoil starter

The recoil starter (1) is used to start the engine when the battery is low. See *Using the Recoil Starter*, page 59 .