

NOTE:

If a torque wrench was not used for installation, see your authorized Honda dealer before operating the vehicle to verify proper assembly.

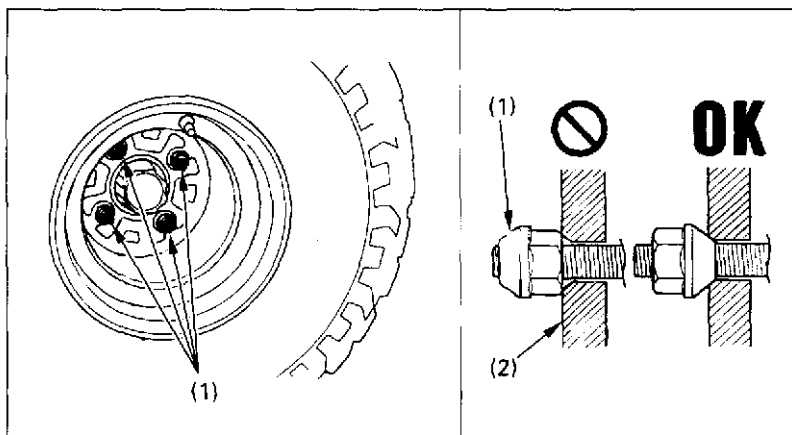

Fig. 4-30 (1) Wheel nuts

(2) Wheel rim

TYRES

This FOURTRAX is equipped with low pressure tubeless tyres. Although the tyres are designed specifically for off-road use, they are not immune to punctures. Always select your riding area with care.

Tyre Pressure

Check the tyre pressure frequently with the air pressure gauge supplied with the vehicle. For normal use, the tyres should be inflated to the pressure recommended in Fig. 4-31.

NOTE:

- * Tyre pressure should be checked before you ride, when the tyres are "cold." Be sure to check tyre pressure at the riding site, since changes in altitude can affect air pressure.
- * A manually operated tyre pump should be used rather than the high pressure systems found in service stations. This will minimize the possibility of tyre damage from overinflation. If you use a high pressure system at a service station, add air in small amounts and check the pressure increase frequently to prevent possible tire damage from overinflation.