

GEARSHIFT CONTROLS

Gearshift Pedal

The gearshift pedal is near the left footpeg. One full stroke of the pedal shifts the transmission to the next higher or lower gear in the shifting sequence (Fig. 2-12). The pedal automatically returns to the horizontal position when released.

Your FOURTRAX has five-forward gears (1, 2, 3, 4 and 5). To shift the transmission, pull in the clutch lever, then operate the gearshift pedal as follows.

To upshift to a higher gear, put the toe of your boot under the gearshift pedal and raise the pedal one full stroke. To downshift, step on the gearshift pedal and depress the pedal one full stroke. (For further operational instructions, see page 57.)

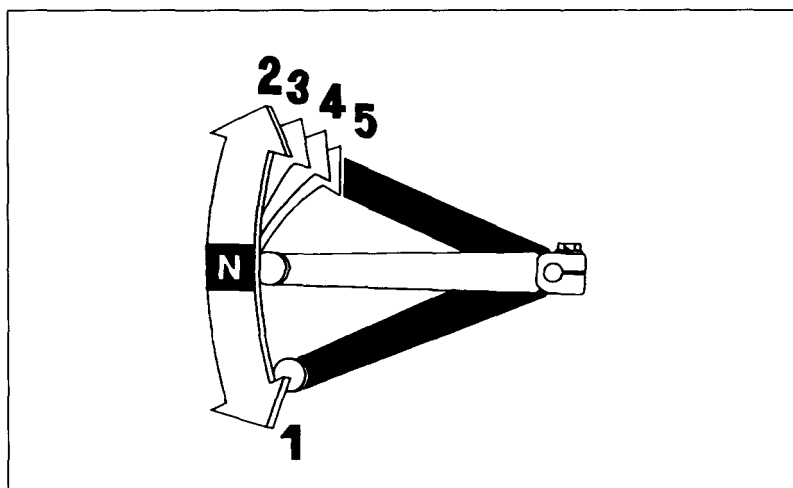

Fig. 2-12

Gearshifting sequence