

Gear Case Oil

1. Park the ATV on level ground.
2. Place an oil drain pan under the oil drain plug (1).
3. Remove the oil filler cap (2) and the drain plug.
4. After the oil has completely drained, reinstall the drain plug and tighten it to the specified torque:
9 lbf·ft (12 N·m , 1.2 kgf·m)
5. Fill the gear case with the recommended oil.
2.9 US oz (85 cm³ , 3.0 Imp oz)
6. Remove the oil level check bolt (3). Make sure the oil level reaches the oil level check hole (4).
7. Install the oil filler cap.

REAR

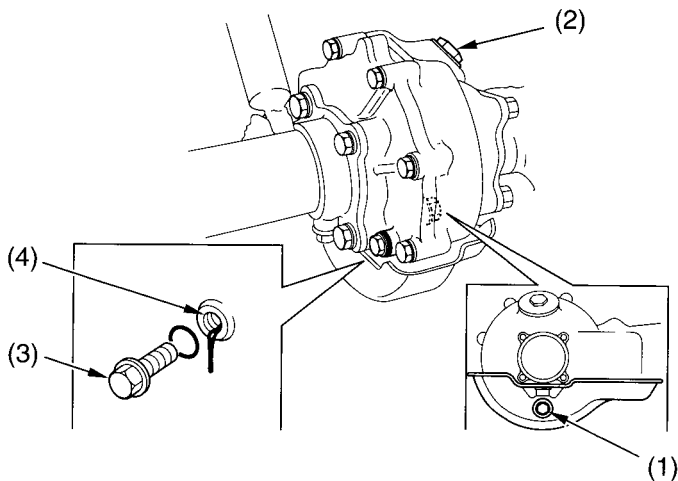

(1) oil drain plug
(2) oil filler cap

(3) oil level check bolt
(4) oil level check hole