

Front Brake Fluid Level:

Check if the fluid level is below the lower level mark (1) through the inspection window (2).

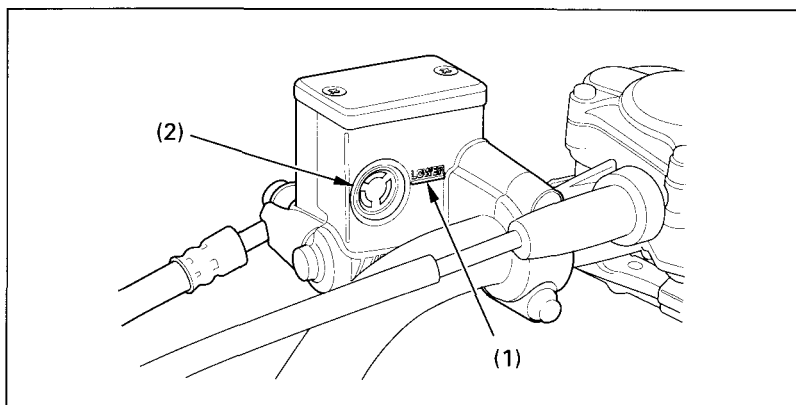

Fig. 4-23 (1) Lower level mark (2) Inspection window

⚠ WARNING

POTENTIAL HAZARD

Brake fluid contacting the skin or eyes.

WHAT CAN HAPPEN

May cause irritation.

HOW TO AVOID THE HAZARD

Avoid contacting brake fluid with the skin or eyes. In case of contact, flush thoroughly with water and call a doctor if your eyes were exposed.