

## SPARK ARRESTER

The spark arrester must be serviced every 100 operating hours to maintain its efficiency.

Regular servicing prevents carbon buildup (which can diminish engine performance) and also complies with USDA regulations for regular maintenance to assure proper function. The spark arrester prevents random sparks from the combustion process in your engine from reaching the environment.

To purge the system:

1. Allow the engine and muffler to cool.
2. Remove the three bolts (2), the spark arrester (1), and the gasket (3) from the muffler (4).

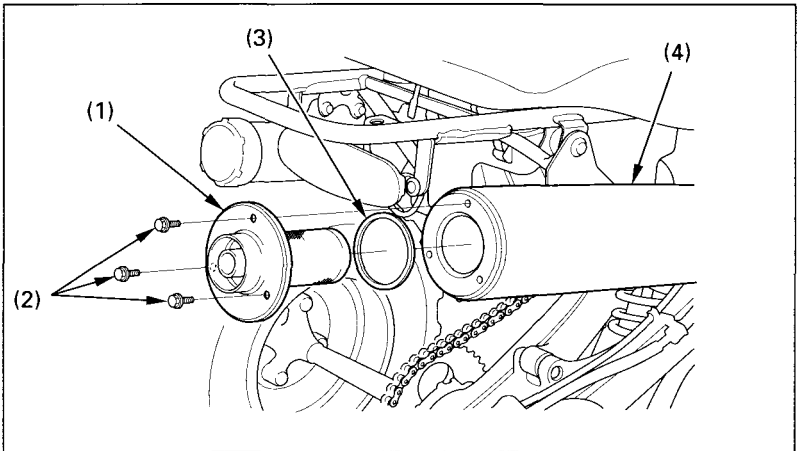

Fig. 4-34 (1) Spark arrester  
(2) Bolts

(3) Gasket  
(4) Muffler