

Starter Button

The starter button (Fig. 2-7) is below the engine stop switch. To start the engine, press the starter button (1), with the transmission in neutral, the ignition switch ON (I) and the engine stop switch (2) at RUN (O).

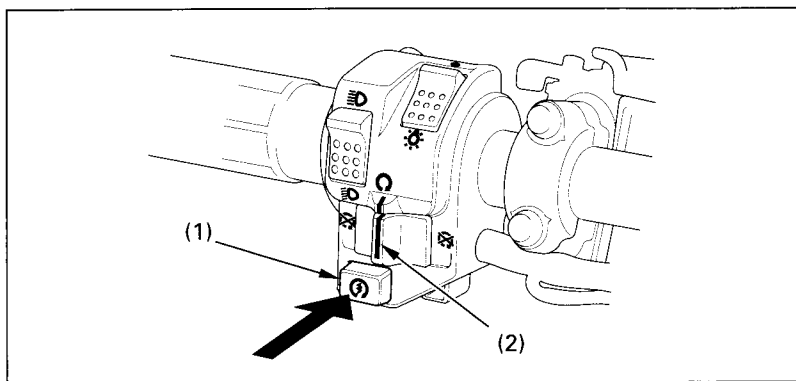

Fig. 2-7 (1) Starter button

(2) Engine stop switch