

## LIGHTS

### Headlight and Dimmer Switches

The headlight and dimmer switches (Fig. 2-10) are above the engine stop switch, next to the left handgrip.

Turning the headlight switch (1) ON (☼) turns the headlight on. Use the dimmer switch (2) to select either high beam HI (≡D) or low beam LO (≡D).

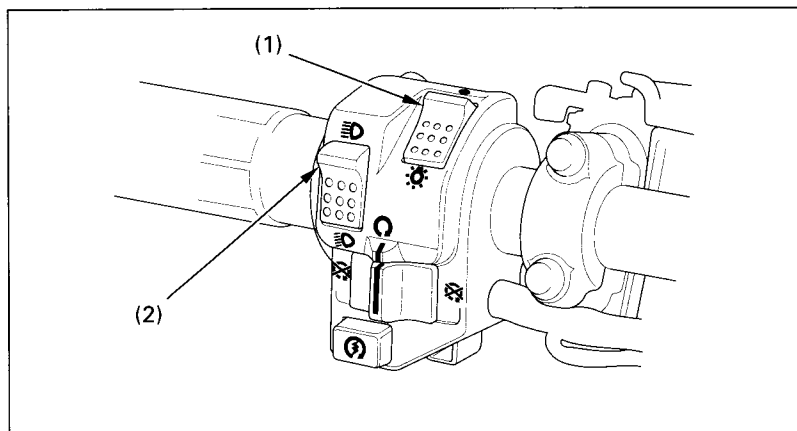

Fig. 2-10 (1) Headlight switch

(2) Dimmer switch