

- (27) Fuel valve
- (28) Starting primer knob
- (29) Storage compartment, containing:
  - Tool kit
  - Air pressure gauge
  - Owner's Manual
- (30) Gearshift pedal
- (31) Oil filler cap/dipstick
- (32) Left footpeg
- (33) Trailer hitch

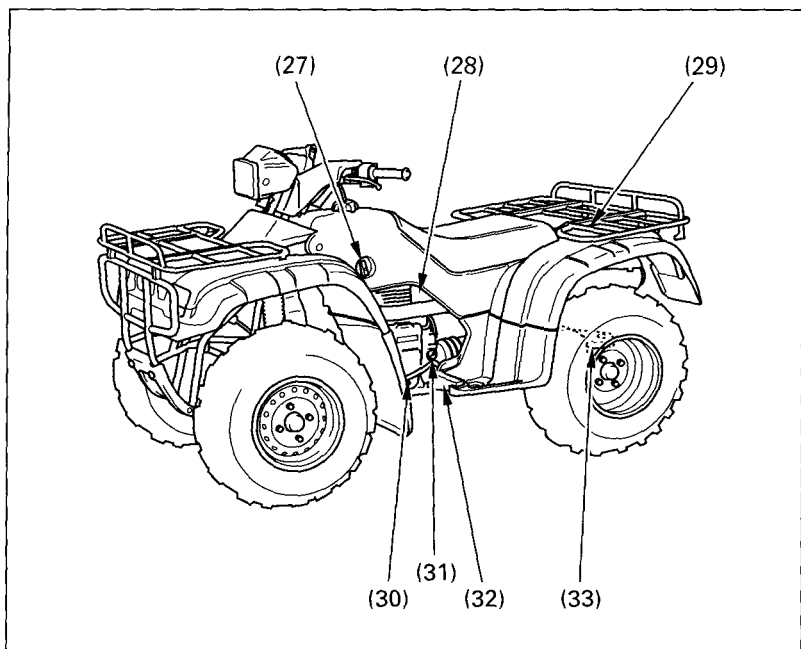

Fig. 2-4

Left side of FOURTRAX