

Coolant

4. Remove the radiator grill (6) from the frame.
5. Wash the radiator grill and radiator core (7).

NOTICE

High pressure water (or air) can damage the radiator core.

LEFT SIDE

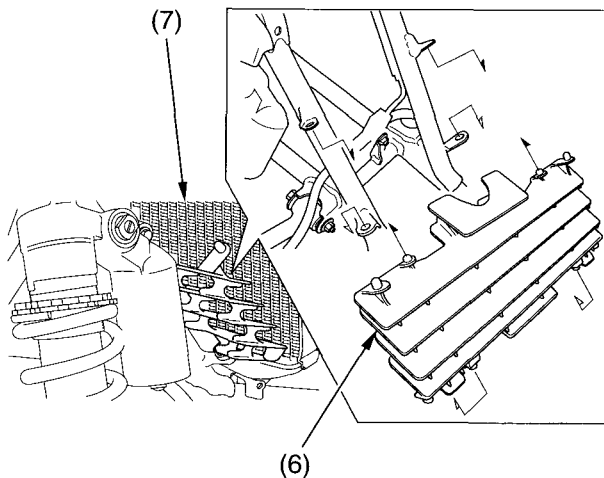

(6) radiator grill

(7) radiator core

6. Install the radiator grill, right and left shrouds and steering cover in the reverse order of removal.