







## RIGHT HANDLEBAR CONTROLS

### Engine Stop Switch

The engine stop switch (1) is next to the throttle grip. When the switch is in the  (RUN) position, the engine will operate. When the switch is in the  (OFF) position, the engine will not operate. This switch is intended primarily as a safety or emergency switch and should normally remain in the  (RUN) position.

### Headlight Switch <Except U type>

The headlight switch (2) has three positions; ,  and OFF marked by a dot to the right of .

: Headlight, taillight, position light and meter lights on.

: Position light, taillight and meter light on.

OFF(dot): Headlight, taillight, position light and meter lights off.

### Starter Button

The starter button (3) is below the headlight switch (2).

When the starter button is pressed, the starter motor cranks the engine. If the engine stop switch is in the  (OFF) position, the starter motor will not operate. See page 40 for the starting procedure.

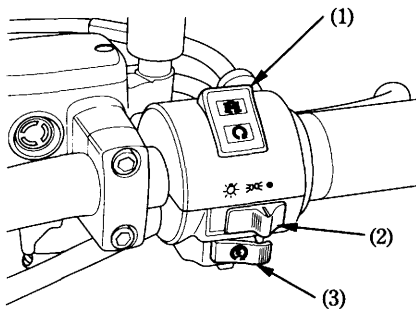

- (1) Engine stop switch
- (2) Headlight switch
- (3) Starter button