

(1) SCREWS
(2) BANK ANGLE SENSOR

Bank angle sensor inspection

Remove the electric stay assembly from the frame (page 6-2).

Remove the screws and bank angle sensor from the sensor bracket.

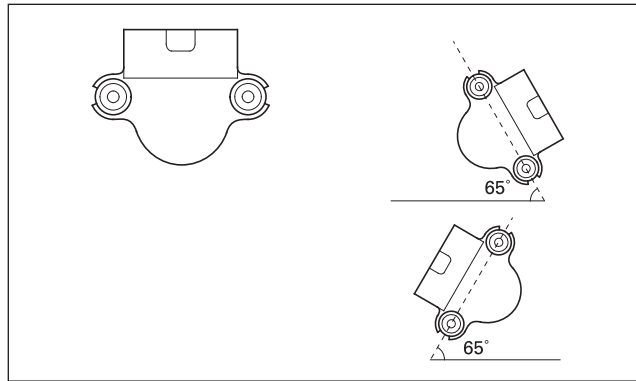

Connect the bank angle sensor 3P (Natural) connector. With the arrow mark on the bank angle sensor facing up, start the engine.

Incline the bank angle sensor approximately 65 degrees to the left or right, make sure that the engine stops after few seconds. If the engine stops, the bank angle sensor is normal. If the engine does not stop, replace the bank angle sensor.

With the arrow/UP mark on the bank angle sensor facing up again, restart the engine. The engine starts, the bank angle sensor is normal.

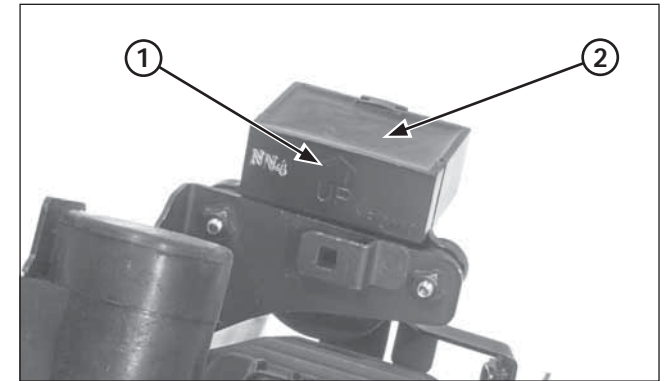

(1) ARROW/UP MARK
(2) BANK ANGLE SENSOR

Install the bank angle sensor in the reverse order of removal. Install the bank angle sensor with its arrow/UP mark facing up as shown.