

Throttle

Refer to *Important Safety Precautions* on page 31.

Throttle Freeplay

Inspection

Check freeplay (1).

Freeplay: 1/8 – 1/4 in (3 – 6 mm)

If necessary, adjust to the specified range.

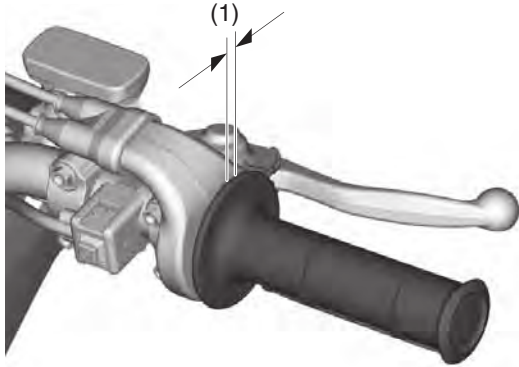

(1) freeplay

Upper Adjustment

Minor adjustments are generally made with the upper adjuster.

1. Loosen the lock nut (1).
2. Turn the adjuster (2).
Turning the adjuster in direction (–) will decrease freeplay and turning it in direction (+) will increase freeplay.

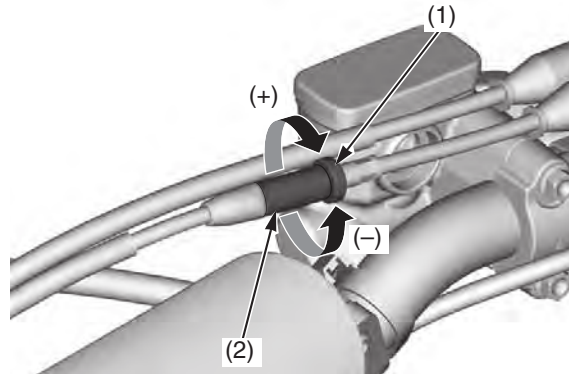

(1) lock nut
(2) adjuster
(+) increase freeplay
(–) decrease freeplay

3. Tighten the lock nut securely.
4. After adjustment, check for smooth rotation of the throttle grip from fully closed to fully open in all steering positions.
If the adjuster is threaded out near its limit or the correct freeplay cannot be reached, turn the adjuster all the way in and back out one turn. Tighten the lock nut securely. Make the adjustment with the lower adjuster.

Lower Adjustment

The lower adjuster is used for major freeplay adjustment, such as after replacing the throttle cables or removing the throttle body. It is also used if you cannot get the proper adjustment with the upper adjuster.

1. Loosen the lock nut (1).
2. Turn the adjuster (2) in direction (–) to decrease freeplay, and in direction (+) to increase freeplay.

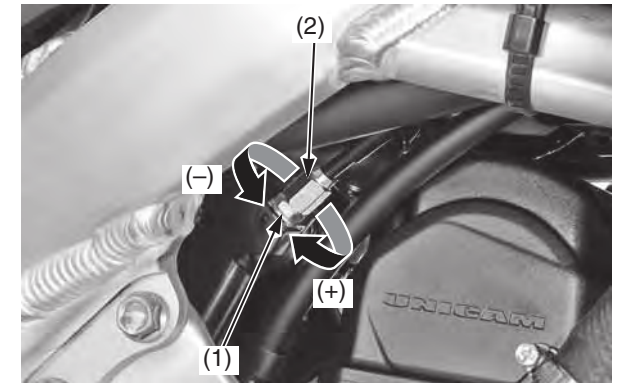

(1) lock nut
(2) adjuster
(+) increase freeplay
(–) decrease freeplay

3. Tighten the lock nut to the specified torque:
3.0 lbf·ft (4.0 N·m, 0.4 kgf·m)
4. Operate the throttle grip to ensure that it functions smoothly and returns completely.

If you can't get the freeplay within the specified range, contact your dealer.