

The following suggestions may improve a specific concern. Subtle changes in overall handling may also be noted.

Rear End

If you have a problem with rear wheel traction, raise the rear end of your CRF by increasing the rear suspension spring pre-load. Instead of running 3.9 in (100 mm) of sag, you can run 3.5 in (90 mm) so the rear of the motorcycle will sit a little higher. This should produce more traction because of the change to the swingarm and location of your CRF's center of gravity.

If you have a problem with the steering head shaking when you use the front brake hard or if your CRF wants to turn too quickly, lower the rear of the motorcycle by reducing the rear suspension spring pre-load. This will increase fork rake and trail and should improve stability in a straight line. The effective suspension travel will be transferred toward the firmer end of wheel travel.

Keep the race sag adjustment (page 146) in the 3.7 – 4.5 in (95 – 115 mm) range.

Fork Height/Angle

The position of the fork in the clamp is not adjustable.

Standard Position

The groove (1) in the outer tube is aligned with the top surface of the upper fork bridge (2).

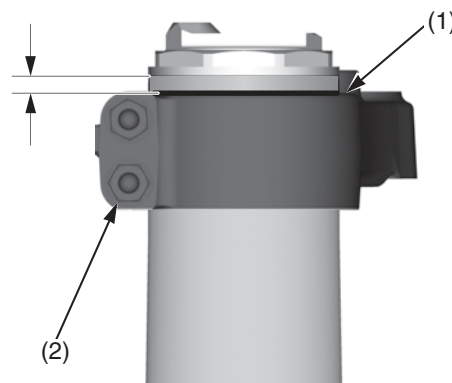

- (1) groove
- (2) upper fork bridge

Wheelbase

Adjusting your CRF's wheelbase can offer subtle changes in overall handling. You may adjust wheelbase by adding or removing links on the drive chain. If you change the wheelbase, be sure to recheck race sag and adjust, if necessary.

In the past, a general rule was lengthen the wheelbase to add straight line stability, shorten the wheelbase to improve turning. However, we suggest you do not lengthen the wheelbase of your CRF unless you are racing on a track with more fast sections than normal.

As a general recommendation, keep the wheelbase as short as possible. This positions the wheels closer together, improves turning response, increases weighting (traction) on the rear wheel, and lightens weighting on the front wheel.

With your CRF, you will probably find that the standard setting or a shorter wheelbase will offer more overall benefits.

