

Battery

The battery is located in a compartment under the seat.

UNDER SEAT

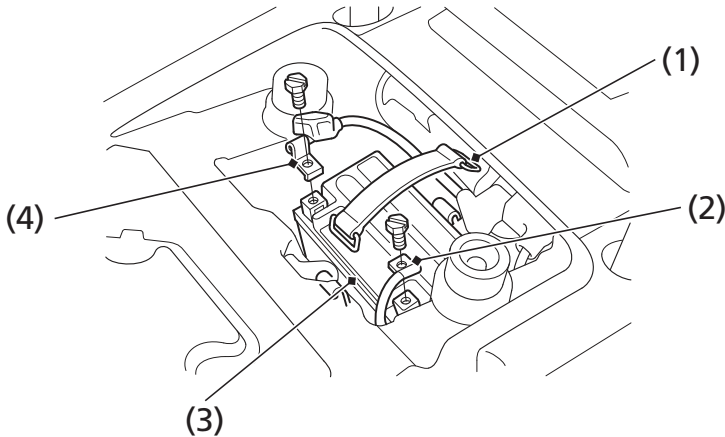

(1) rubber band

(3) battery

(2) negative (-) terminal lead

(4) positive (+) terminal lead

Removal

1. Make sure the ignition switch is OFF (w).
2. Remove the seat (page 88).
3. Release the rings and remove the rubber band (1).
4. Disconnect the negative (-) terminal lead (2) from the battery (3) first, then disconnect the positive (+) terminal lead (4).
5. Remove the battery.