

Fluid Level Inspection

Refer to *Safety Precautions* on page 79.

With the ATV in an upright position, check the fluid level. It should be above the LOWER level mark (1).

If the fluid is below the LOWER level mark, have your dealer add the recommended fluid.

Do not add or replace brake fluid, except in an emergency. Use only fresh brake fluid from a sealed container. If you do add fluid, have your dealer check the system as soon as possible.

NOTICE

Brake fluid can damage plastic and painted surfaces. Handle with care.

RIGHT HANDLEBAR

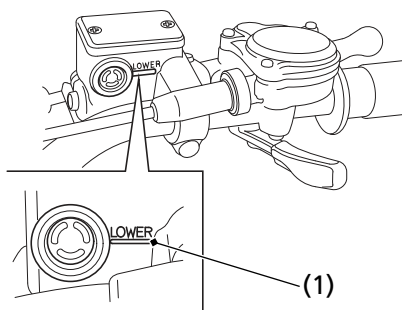

(1) LOWER level mark