

Controls & Features

Gearshift Switch

AUTO (automatic shift mode):

These gearshift switches [upshift switch (1) and downshift switch (2)] are used to select the drive (D), neutral (N) and reverse (R).

See *Shifting Gears*, page 79 and *Riding in Reverse*, page 85.

ESP (manual shift mode):

These gearshift switches are used to select the next higher or lower gear in the transmission. To operate, press the upshift switch (1) to engage the next higher gear or press the downshift switch (2) to engage the next lower gear.

See *Shifting Gears*, page 79 and *Riding in Reverse*, page 85.

LEFT HANDLEBAR

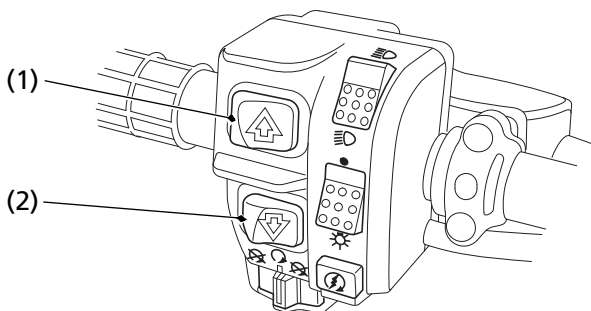

(1) upshift switch

(2) downshift switch