

Rear Fender Cover Removal

Refer to *Safety Precautions* on page 111.

The rear fender cover must be removed for battery, fuse maintenance and to access the owner's manual, and air pressure gauge.

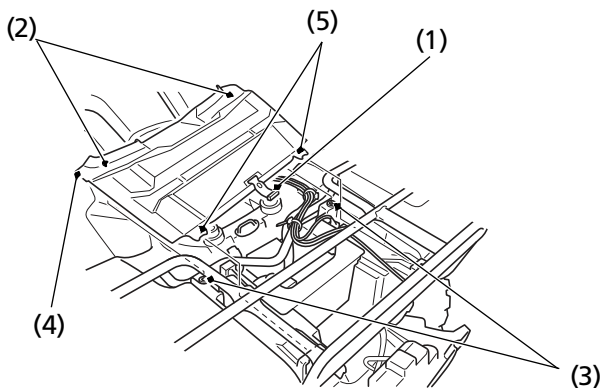

(1) rubber strap

(4) rear fender cover

(2) prongs

(5) tabs

(3) grommets

Removal

1. Remove the seat (page 122).
2. Unhook the rubber strap (1).
3. Firmly pull the prongs (2) from their grommets (3).
4. Slide the rear fender cover (4) forward to disengage the tabs (5).
5. Remove the rear fender cover.

Installation

Install the parts in the reverse order of removal.