

Controls & Features

Gearshift Switch

These switches are used to select the next higher or lower gear in the transmission. To operate, press the upshift switch (1) to engage the next higher gear or press the downshift switch (2) to engage the next lower gear.

See *Shifting Gears*, page 76.

LEFT HANDLEBAR

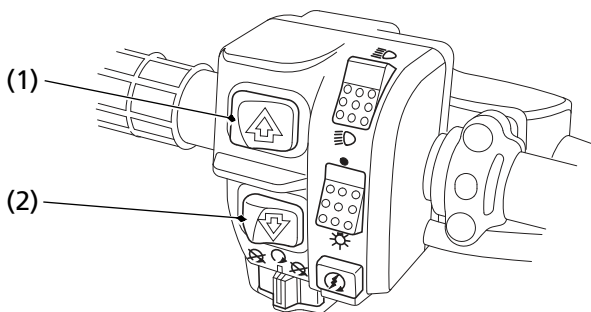

- (1) upshift switch
- (2) downshift switch