

Owner's Manual Storage

Your ATV provides storage for the owner's manual so you'll have it with you for easy reference. Store your owner's manual (1) in the plastic document bag (2) underside of the seat (2).

The owner's manual and air pressure gauge (3) should be stored in the plastic document bag (4).

To remove the seat, see page 100 .

Be careful not to flood this area when washing your ATV.

SEAT UNDERSIDE

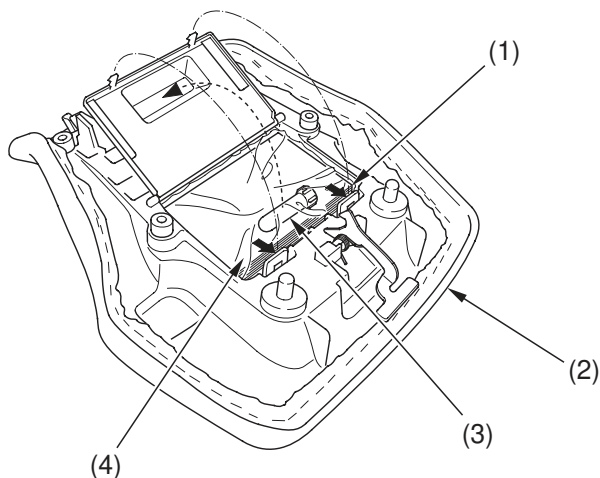

(1) owner's manual
(2) seat

(3) air pressure gauge
(4) plastic document bag