

Battery

The battery is located in a compartment under the rear fender cover.

UNDER REAR FENDER COVER

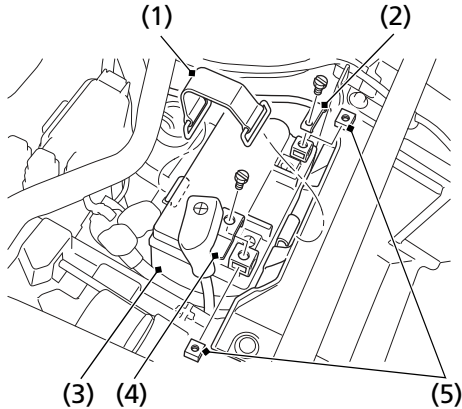

- (1) rubber band (4) positive (+) terminal lead
(2) negative (-) terminal lead (5) terminal nuts
(3) battery

Removal

1. Make sure the ignition switch is OFF (O).
2. Remove the seat ([page 120](#)).
3. Remove the rear fender cover ([page 121](#)).
4. Release the rings and remove the rubber band (1).
5. Disconnect the negative (-) terminal lead (2) from the battery (3) first, then disconnect the positive (+) terminal lead (4).
6. Remove the battery taking care not to drop the terminal nuts (5).

(cont'd)