

Tool Kit

The tool kit (1) is stored under the rear fender cover (page 123). After using the tools, be sure to use the rubber band (2) to fasten the tool kit securely.

An optional, larger tool kit may be available. Check with your dealer's parts department.

UNDER REAR FENDER COVER

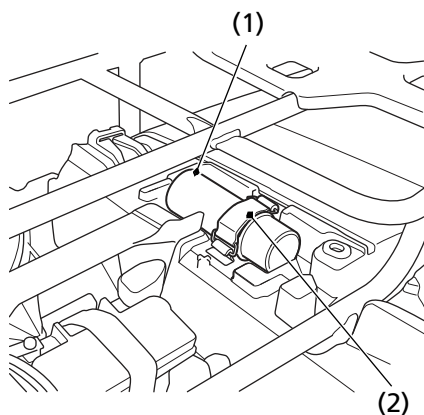

(1) tool kit

(2) rubber band