

# Engine Oil & Filter

## Checking & Adding Oil

Refer to *Safety Precautions* on page 99 .

Check the engine oil level each day before operating your ATV and add if needed.

*Before riding your ATV, check the engine oil level.*

1. Park your ATV on a firm, level surface.
2. Start the engine in a well-ventilated area and let it idle for 3–5 minutes. Stop the engine and wait 2–3 minutes.
3. Remove the dipstick (1) from the front crankcase cover and wipe it clean.
4. Insert the dipstick without screwing it in, then remove the dipstick and check the oil level. The oil level should be between the upper level mark (2) and the lower level mark (3) on the dipstick.

### LEFT SIDE

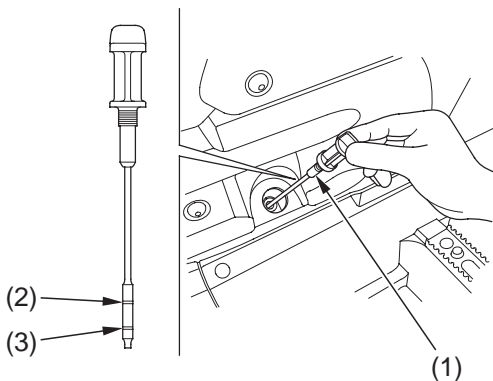

(1) dipstick  
(2) upper level mark

(3) lower level mark

(cont'd)