

Seat Removal

Refer to *Safety Precautions* on page 99.

The seat must be removed for the air cleaner, spark plug and fuse maintenance, and access to the tool kit.

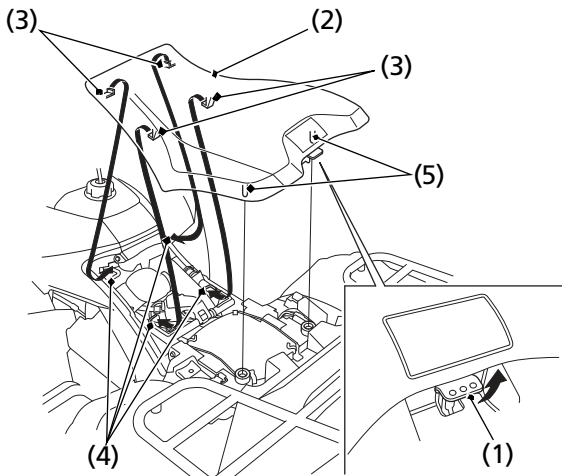

(1) seat latch

(4) hooks

(2) seat

(5) studs

(3) front prongs

Removal

1. Pull the seat latch (1) at the rear of the seat.
2. Slide the seat (2) back and lift it.

Installation

1. Insert the front prongs (3) into the hooks (4) and press the studs (5) into the grommets on the rear fender.
2. Press down on the seat until it locks.