

6. Remove the oil filter with a filter wrench and let the remaining oil drain out. Make sure the prior seal is not stuck to the engine.
 - Discard the oil and oil filter at an approved recycling center.

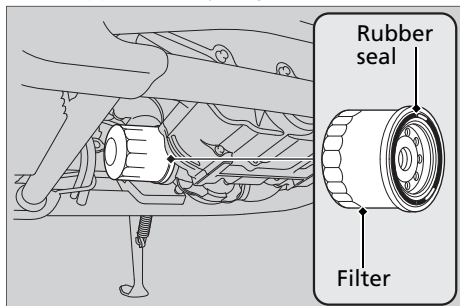

7. Apply a thin coat of engine oil to the rubber seal of a new oil filter.
8. Install a new oil filter and tighten.

Torque: 19 lbf·ft (26 N·m, 2.7 kgf·m).

9. Install a new sealing washer onto the drain bolt. Tighten the drain bolt.

Torque: 22 lbf·ft (30 N·m, 3.1 kgf·m).

10. Fill the crankcase with the recommended oil (► P. 41) and install the oil fill cap/dipstick.

Required oil

When changing oil & engine oil filter:

2.7 US qt (2.6 liters)

When changing oil only:

2.6 US qt (2.5 liters)

11. Check the oil level. ► P. 52
12. Check that there are no oil leaks.