

COOLING SYSTEM

THERMOSTAT

REMOVAL

Drain the coolant (page 7-6).

Remove the throttle body (page 6-72).

Remove the bolts and thermostat housing cover.

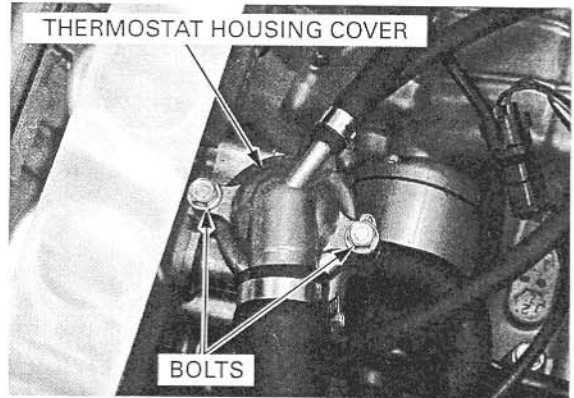

Remove the thermostat from the housing.

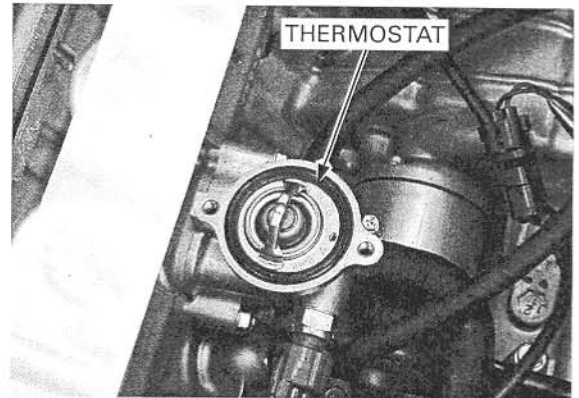

INSPECTION

Wear insulated gloves and adequate eye protection. Keep flammable materials away from the electric heating element.

Visually inspect the thermostat for damage. Check for damage of the seal ring.

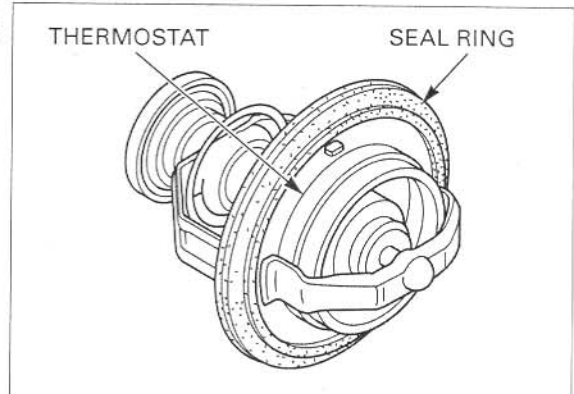

Do not let the thermostat or thermometer touch the pan, or you will get false reading.

Heat the water with an electric heating element to operating temperature for 5 minutes. Suspend the thermostat in heated water to check its operation.

Replace the thermostat if the valve stays open at room temperature, or if it responds at temperatures other than those specified.

THERMOSTAT BEGIN TO OPEN:

80 – 84 °C (176 – 183 °F)

VALVE LIFT:

8 mm (0.3 in) minimum at 90 °C (194 °F)

